

## Serie X5

---

TPX 550

---

TPX 551

---

TPX 552

---

TPX 555

---



# Serie X5

---

TAMPONDRUCKMASCHINEN  
PAD PRINTING MACHINES

---

 **Teca-Print**  
 **Teca-Print**

# Serie X5 & Peripheriegeräte

## Serie X5 & peripherals



TPX 550 – 6-Farbendruck – mit Transfert Carré und Tamponreinigung  
 TPX 550 – 6 colour print – with Transfert Carre and pad cleaning device

TPX 555 mit Tamponreinigung – 4 Farbendruck mit einem STARX-Tampon  
 TPX 555 with pad cleaning device – 4 colour print with one STARX-pad



TPX 552 – 2-Farbendruck – mit Topfquerverschiebung  
 TPX 552 – 2 colour print – and lateral cup inking mechanism



TPX 550 mit Verschiebetisch und Sicherheitsverschalung mit Lichtschranke  
 TPX 550 with shuttle table and safety guarding with light curtain



TPX551 – 4-Farbendruck – mit Tamponhöhenausgleich, 3 Rundtöpfen und 1 Ovaltopf und Tamponreinigung  
 TPX 551 – 4 colour print – with pad height compensators, 3 standard ink cups, 1 oval ink cup and pad cleaning device

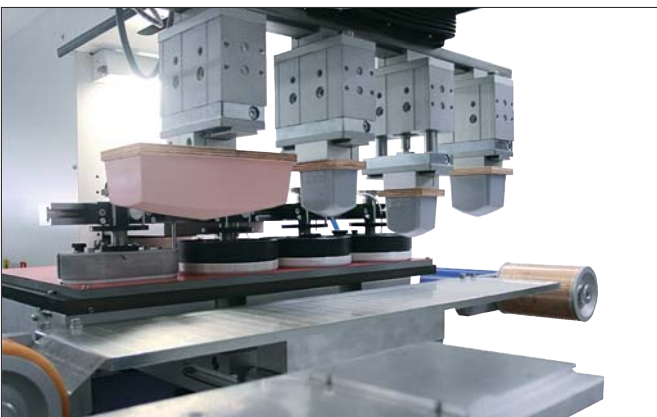

# Eigenschaften der Serie X5

## Characteristics of the Serie X5

● Mit einem Höchstmass an technischen Raffinessen ausgestattet sind die elektromechanischen Tampondruckmaschinen der Serie X5. Die über drei Servomotoren angetriebenen Maschinen sind mit offenem oder geschlossenem Farbgebersystem sowie mit Topquerverschiebung erhältlich und erfüllen so die Anforderungen der Kunden in den verschiedensten Bereichen. Komfortable Bedienung über den Touch-Screen-Monitor, das Klischeeschnellwechselsystem und Einstellmöglichkeiten in x-, y- und z-Achse über die Klischeehalterung bzw. die Maschine selbst sind bei diesen hochtechnischen Maschinen selbstverständlich. Eine integriert erhältliche Tamponreinigung sowie Peripheriegeräte wie Verschiebetisch und Transfert Carré ohne separate Steuerung ergänzen das vielfältige Angebot zu den Maschinen der Serie X5.

● Teca-Print's Serie X5 offers a world of new possibilities with its new electro-mechanical pad printing machines. The new Serie X5, which offer servo drives for all three axis, are available in sealed cup, open ink well, and lateral cup configurations. The Serie X5 also boasts of an overall "easy to use" design concept. The Serie X5 machine offers a Touch Screen Panel, fast cliché change over with an effortless x-, y-, z- directional adjustment system. The Serie X5 will be able to easily satisfy a wide range of technical printing demands because of its flexibility and numerous user-friendly features which will improve your production and efficiency.

# Tamponpositionen frei wählbar

## Pad positions infinitely programmable

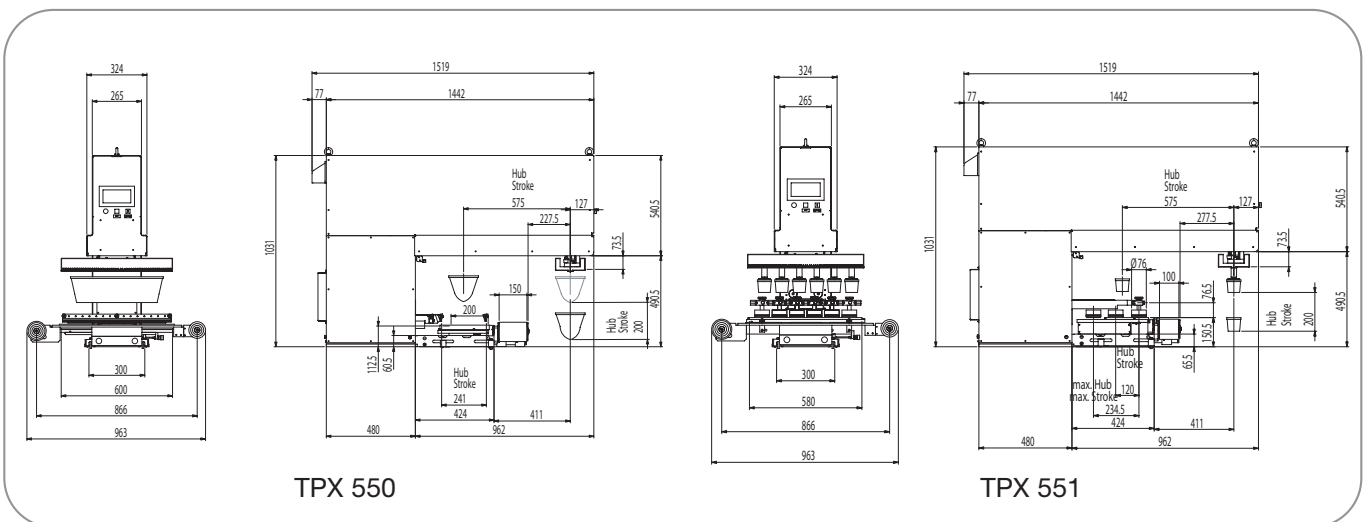
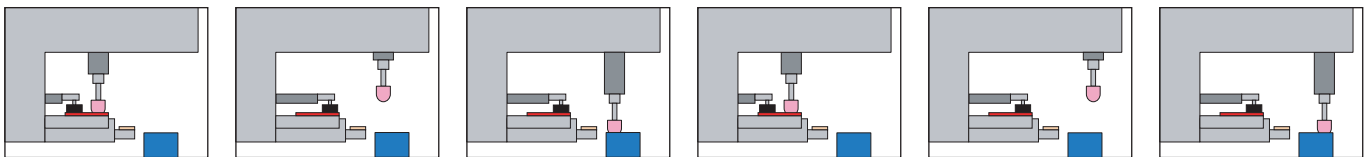

● Flexibilität versprechen die Maschinen der Serie X5 durch die horizontal und vertikal stufenlos einstellbare Tamponposition. Unterschiedliche Höhen bei Farbaufnahme, Farbabgabe und Tamponreinigung sind innerhalb eines Druckzyklus möglich, bei gleichzeitig, auch in horizontaler Richtung, verschiedenen Positionen. Verschieden hohe Ebenen können so beispielsweise in einem Arbeitsgang bedruckt werden.

● Teca-Print's Serie X5 provides customers with one of the most flexible, production cost-reducing machines available on the market today. Parts can be printed on different positions, whether the length, width, or depth, and within the same print cycle. Program options allow for multiple ink pick up and drop off points, reducing consumable costs and change-over times. These are some ways that the flexibility of Teca-Print's Serie X5 can help your company save time and reduce the overall printing costs.



TPX 552 und TPX 555 auf Anfrage  
TPX 552 and TPX 555 on demand





TECHNISCHE DATEN	TPX 550		TPX 551		TPX 552	TPX 555	
Farbtopfgrößen: 			72/86/96/115/130/160/195*		72/86/96/115/130/160/195*	72/86/96/115/130/160/195*	
Farbtopfgrößen: 			70x140/116x226/115x320/120x96			70x140/116x226/115x320/120x96	
Max. Anzahl Farben:	6		6		2	6	
Standardklischeegrößen (mm):	450 x 150	600 x 150	125 x 260	350 x 220		125 x 260	350 x 220
	350 x 150	600 x 180	150 x 300	580 x 220		150 x 300	580 x 220
	600 x 150	600 x 200	180 x 350	580 x 260		180 x 350	580 x 350
				580 x 350			

1. Taktzahl:	bis 1500 pro Stunde	bis 1200 pro Stunde	
2. Antrieb:	elektromechanisch		
3. Druckkraft:	6000 N bei zentraler Belastung		
4. Elektrischer Anschluss:	230 V / 50 Hz		
5. Steuerung:	Prozessor SPS Omron / Touchscreen		
6. Tamponausladung:	ohne Tamponreinigung bis 411 mm		
7. Gewicht ohne / mit Sockel:	ca 280 kg / 470 kg	305 kg / 495 kg	
8. Abmessungen:	Breite	Höhe	Tiefe
(ohne Sockel)	963 mm	1031 mm	1519 mm
9. Optionen Peripherie:	Tamponreinigung TAC, Verdünnierzuführung TI 300, Verschiebetische, Transfert Carré, Rundscharftische, höhenverstellbares Gestell,		1600 x 1070 x 1519 mm ohne Verschiebetische und Transfert Carré
10. Optionen Zubehör:	Koordinatentische, Maschinensockel, Tampon- & Teile-Verschiebevorrichtungen, Aufnahmetische		

\* Topfüberlappung

Technische Änderungen vorbehalten

TECHNICAL DATA	TPX 550		TPX 551		TPX 552	TPX 555	
Ink cup sizes: 			72/86/96/115/130/160/195*		72/86/96/115/130/160/195*	72/86/96/115/130/160/195*	
Ink cup sizes: 			70x140/116x226/115x320/120x96			70x140/116x226/115x320/120x96	
Max. number of colours:	6		6		2	6	
Standard plate sizes (mm):	450 x 150	600 x 150	125 x 260	350 x 220		125 x 260	350 x 220
	350 x 150	600 x 180	150 x 300	580 x 220		150 x 300	580 x 220
	500 x 150	600 x 200	180 x 350	580 x 260		180 x 350	580 x 350
				580 x 350			

1. Print capacity:	up to 1500 cycles per hour	up to 1200 cycles per hour	
2. Drive:	electromechanical		
3. Force of pressure:	6000 N based on central force		
4. Electric supply:	230 V / 50 Hz		
5. Control unit:	PLC Processor Omron / Touchscreen		
6. Working area:	up to 411 mm without pad cleaning device		
7. Weight (excl. / incl. base):	280 kg / 470 kg	305 kg / 495 kg	
8. Dimensions:	width	height	depth
(excl. machine base)	963 mm	1031 mm	1519 mm
9. Optional peripherals:	pad cleaning device TAC, thinner injector TI 300, shuttle tables, Transfert Carré, rotary tables, height adjustable peripheral stand,		1600 x 1070 x 1519 mm without shuttle tables and Transfert Carré
10. Optional accessories:	coordinate tables, machine bases, pad & parts sliding devices, and receiver tables		

\*with overlapping cup

We reserve the right to make technical changes without prior notice

**Besuchen Sie unsere Website für mehr Infos über Teca-Print Produkte für den Tampondruck:**

**Visit our website for further information about Teca-Print's pad printing products:**



**Teca-Print**

Teca-Print AG

Tel. +41 (0)52 645 2000

Postfach  
Bohlstrasse 17  
CH-8240 Thayngen

Fax +41 (0)52 645 2102  
info@teca-print.com  
teca-print.com